

RHA ALUMINUM LADDER ACCESS ROOF HATCH

Application

Acudor Ladder Access Roof Hatches are designed to provide convenient, economical access to the roof of a building

Features RHA

- Weather tight construction
- Convenient one-hand operation
- 12" high insulated curb
- Supports 40lbs./sq. ft. live load
- Stainless Steel Hardware

Optional Features RHA

- Painted and Anodized finishes
- Polycarbonate domes for daylighting
- Louvered Curbs
- Curb Mounted Units
- Curb pitch corrected for sloped roof
- Higher curb heights for "green roof" applications

RHA Specifications:

Cover: Double-skin construction ("in box type design") with 1" Polyiso (R-6) insulation and a continuous EPDM foam weather/draft seal gasket that is attached to the inside of cover to provide a flush, tight fit. Designed to support a live load of 40lbs./sq. ft., the cover is 11 gauge aluminum with a 20 gauge aluminum inside liner.

Curb: 11 gauge aluminum with 1" thick Polyiso (R-6) insulation at curb exterior. Curb is 12" high, with 3.375" wide bottom flange and pre-drilled mounting holes.

Hinge: Heavy duty Aluminum pintle hinges with 3/8" SS pin

Opening: Gas spring operators allow cover to open and close with ease. Stainless Steel Inside pull handle allows for easy control when closing cover.

Door Latch: Self latching, Stainless steel outside T handle with stainless steel inside lock and lever assembly. Unit also has inside and outside padlock provisions.

Finish: Mill finish.



RHA STANDARD SIZES (other sizes available)

Model	Curb ID W&L	Weight per Hatch
	inches (mm)	lbs. (kg.)
A3232	24 x 24 (610 x 610)	60 (27.3)
A3238	24 x 30 (610 x 762)	65 (29.4)
A3244	24 X 36 (610 X 914)	70 (31.8)
A3838	30 x 30 (762 x 762)	75 (34.0)
A3844	30 x 36 (762 x 914)	85 (38.6)
A4444	36 x 36 (914 x 914)	95 (43.2)

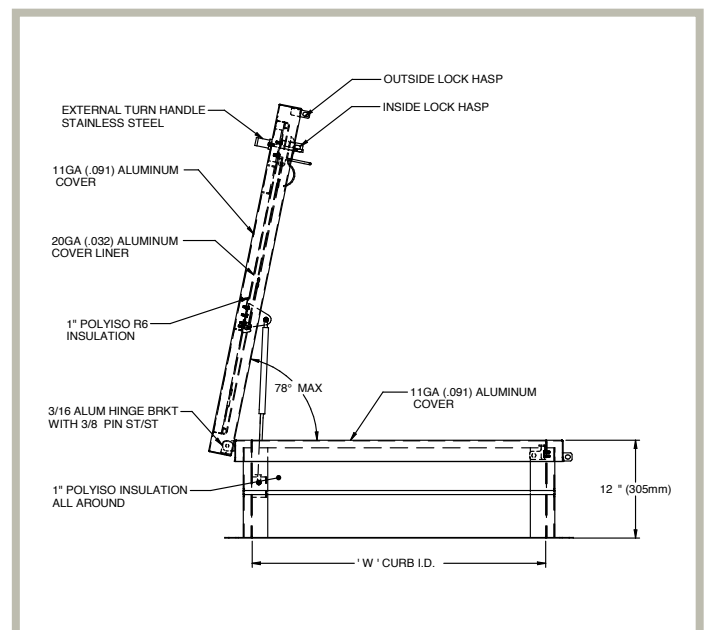

For detailed specifications see submittal sheet